

# CUSTOM BARN DOOR SPECIFICATIONS

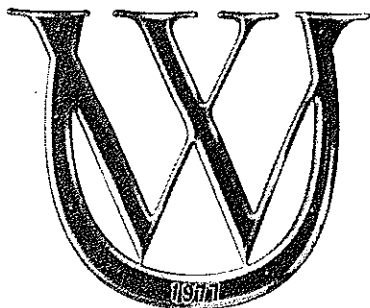
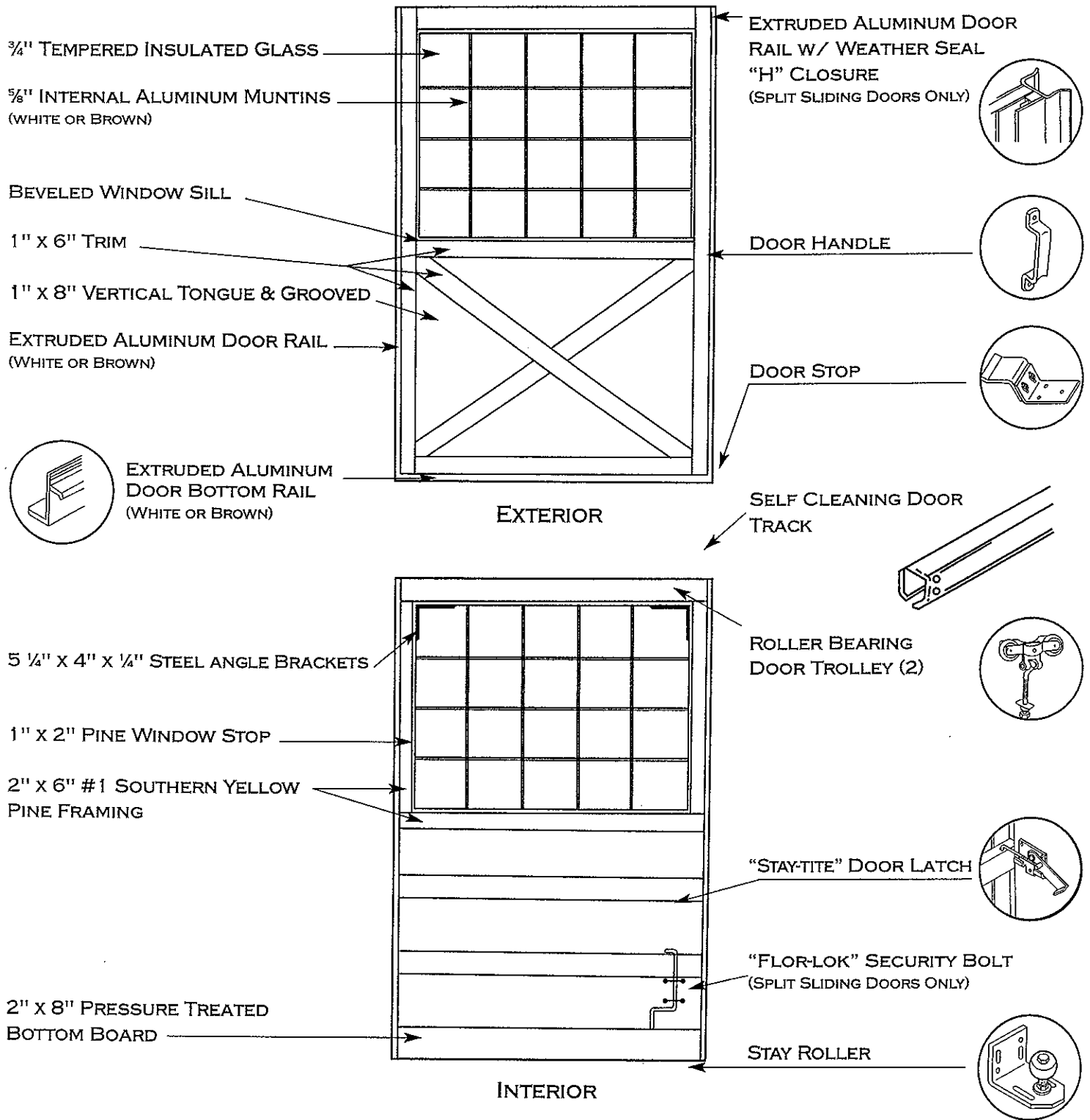

**WOODSTAR PRODUCTS, INC.**

*Your Horse Stall Company Since 1977*

1824 HOBBS DRIVE • DELAVAN, WISCONSIN 53115  
 1.800.648.3415 • PHONE: 262-728-8460 • FAX: 262-728-1813  
 EMAIL: STALLS@WDSTAR.COM • WEBSITE WWW.WDSTAR.COM

# WOODSTAR PRODUCTS, INC.

## CUSTOM BARN DOOR HARDWARE SET FOR TWO DOORS COMING TOGETHER

QUANT.

ITEM

2

TRACKS

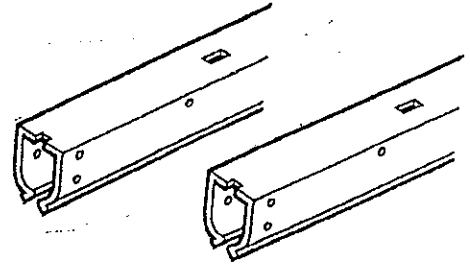

1

SPLICE CLIP

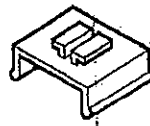

4

9 1/2" TROLLEYS

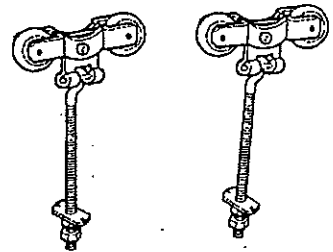

2

STAY TIGHT LATCHES W/ PLATES



2

STAY ROLLERS

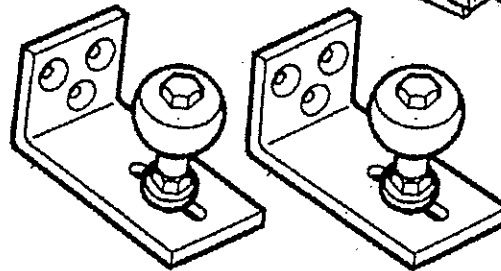

1

EXTERIOR DOOR STOPS

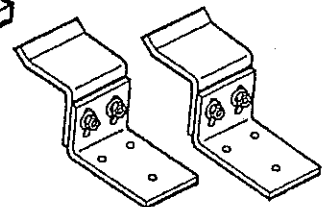

2

DOOR PULLS

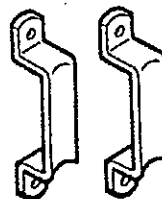

PAGE 1



1824 Hobbs Drive • Delavan, Wisconsin 53115

Phone: (262) 728-8460 • Fax: (262) 728-1813 • (800) 648-3415 • Web: [www.wdstar.com](http://www.wdstar.com) • email: [stalls@wdstar.com](mailto:stalls@wdstar.com)

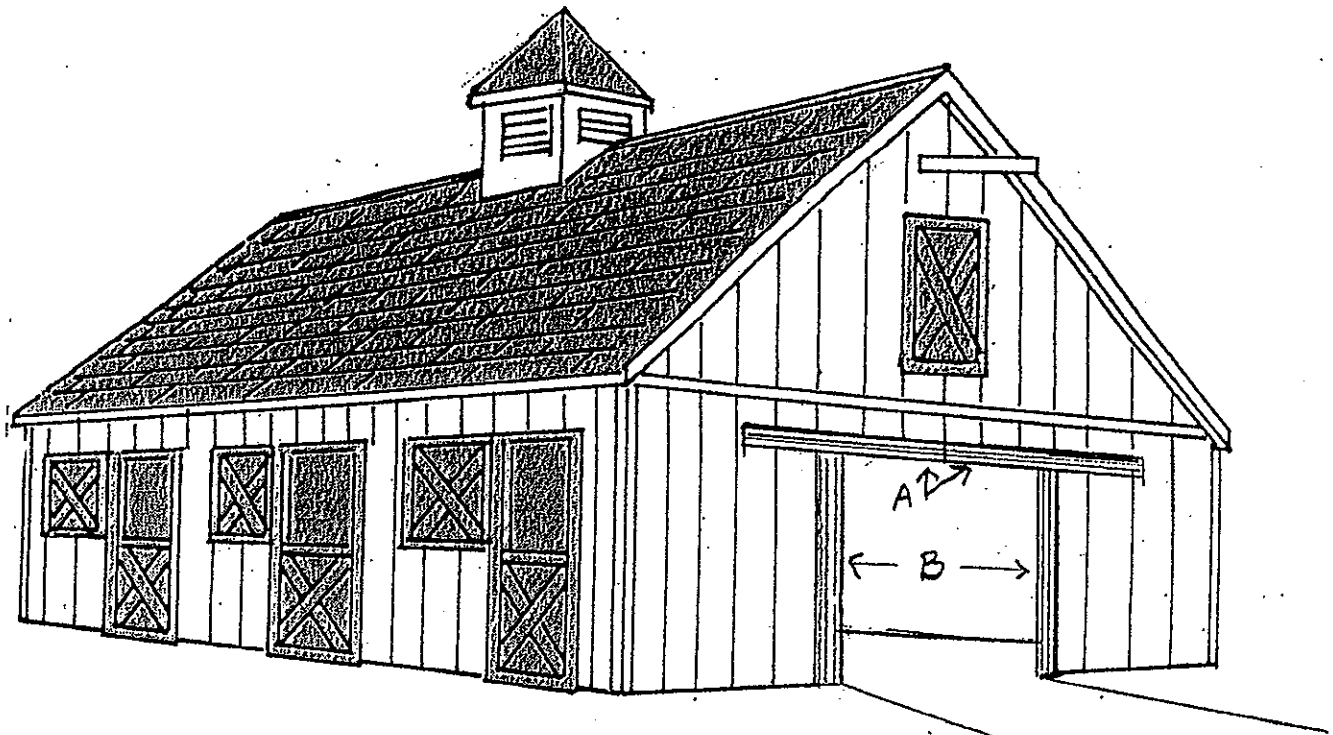

- 1- NAIL 2 X 6 HEADERS OVER TOP OF DOOR OPENING  
TWICE AS LONG AS THE WIDTH OF THE OPENING  
AS SHOWN IN POSITION ( A )**
- 2- NAIL 2 X 6 PLANKS DOWN BOTH SIDES OF OPENING  
FROM BOTTOM OF HEADER TO GRADE  
AS SHOWN IN POSITION ( B )**
- 3- NAIL TRACK TO TOP OF 2 X 6 HEADER USING THE  
OVERHANGING TABS ATTACHED TO TRACK – OR-  
TAKE TABS OFF AND FACE MOUNT TRACK TO THE  
HEADER W/ 1/4" LAGS OR BOLTS AT TOP EDGE OF TRACK**
- 4- INSTALL TROLLEYS ON DOORS AND HANG ON THE TRACK**
- 5- LEVEL & PLUMB DOOR**
- 6- INSTALL REMAINING HARDWARE  
AS SHOWN ON OTHER SPECIFICATION SHEET**

# CUSTOM BARN DOOR TRACK DETAIL

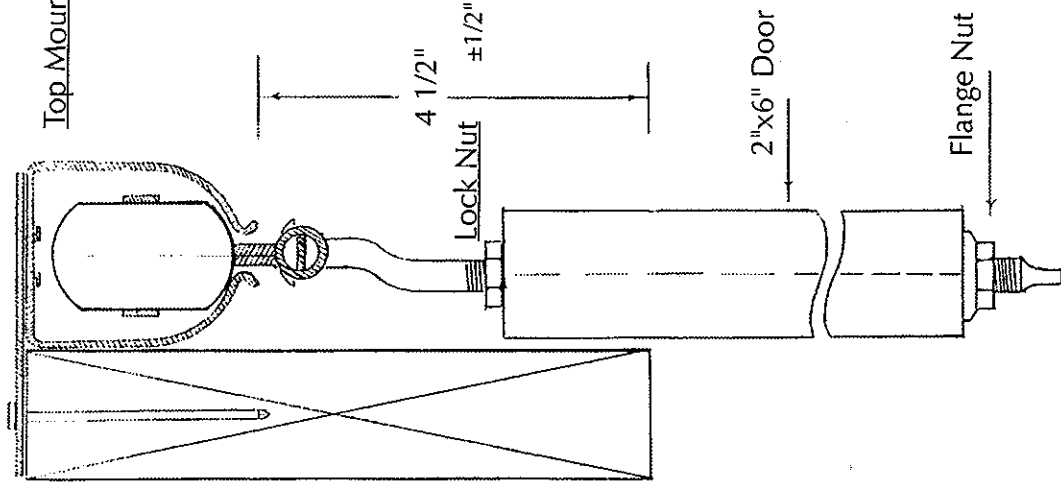
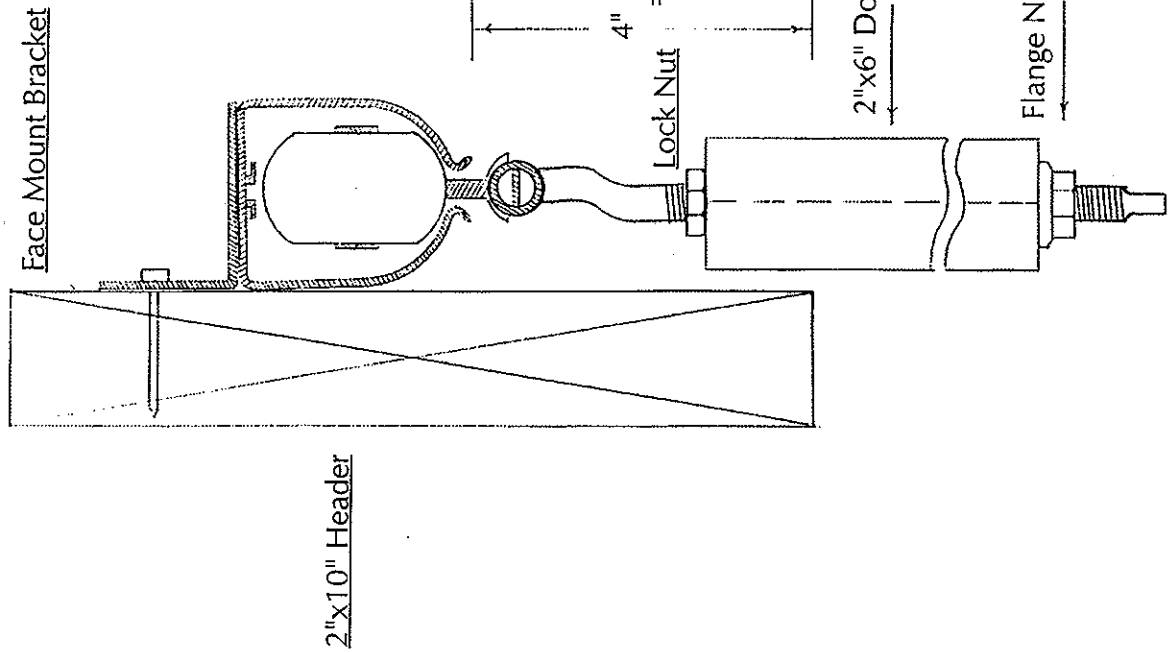

<b>Woodstar Products</b>	
<small>DESIGNED BY</small>	<small>E. Vogel</small>
<small>DATE</small>	<small>REVISED</small>
June 07	
<b>Delavan Wisconsin</b>	
800-648-3415	

**FACE MOUNT TRACK BRACKET**

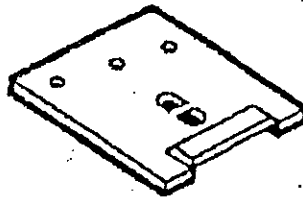
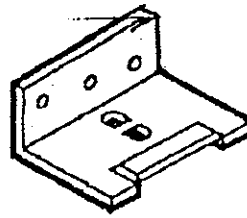

**TOP MOUNT TRACK BRACKETS**

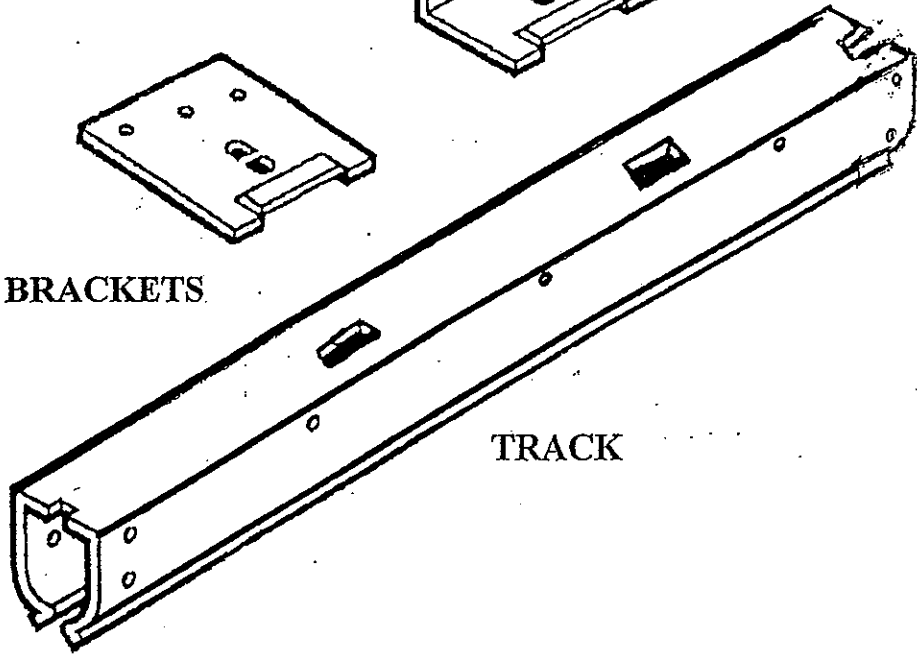

**TRACK**

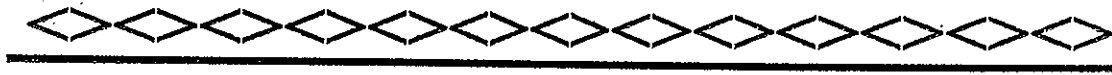

**SPLICE CLIP**

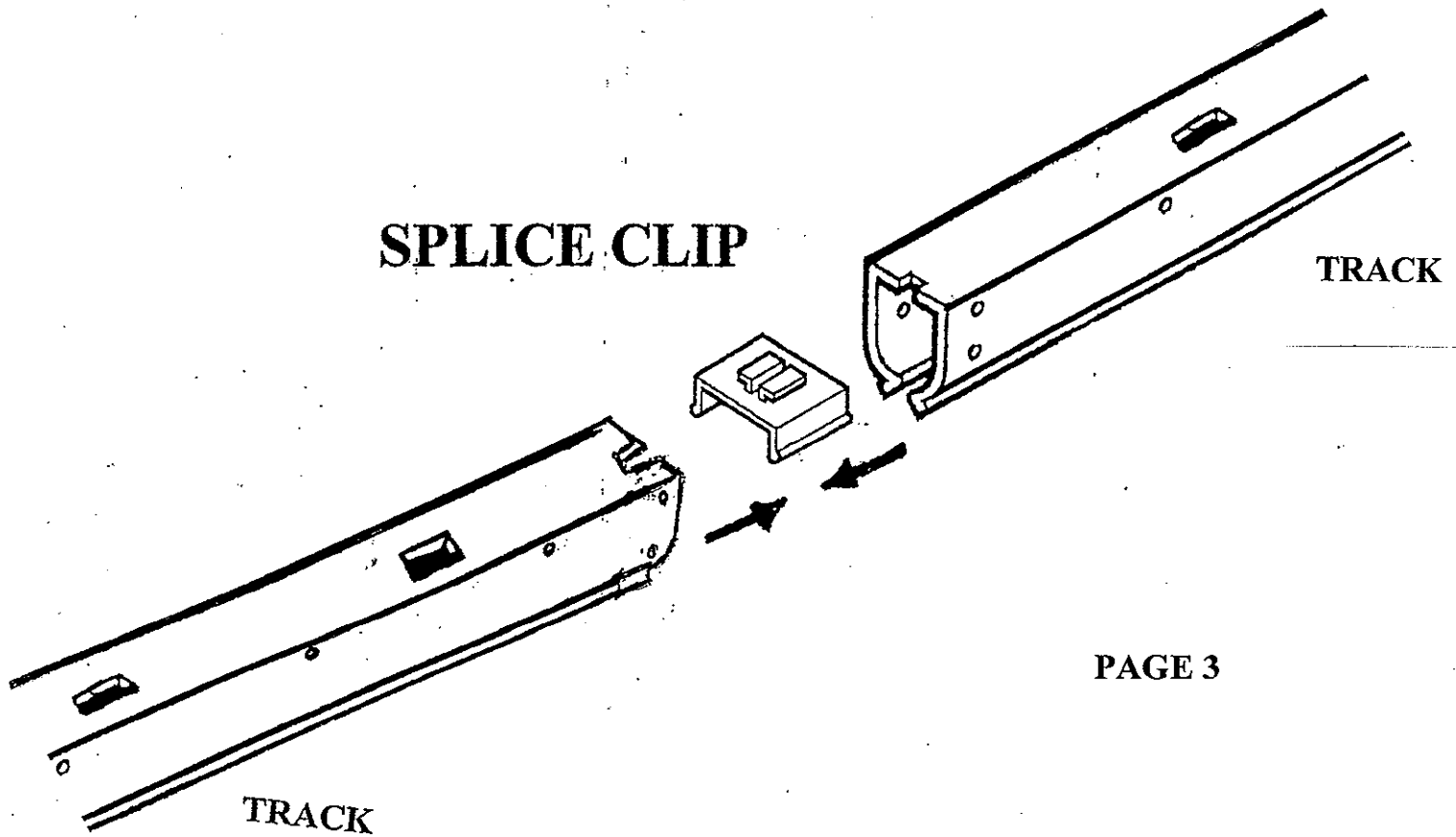

**TRACK**

**TRACK**

# GOOSE NECK BOLT TROLLEYS

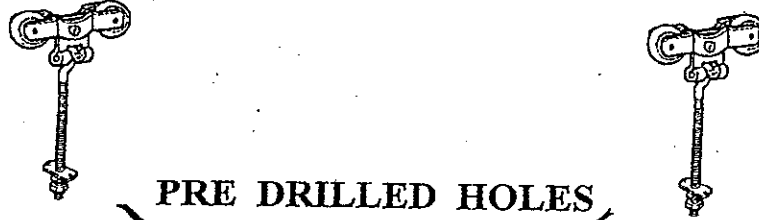

PRE DRILLED HOLES

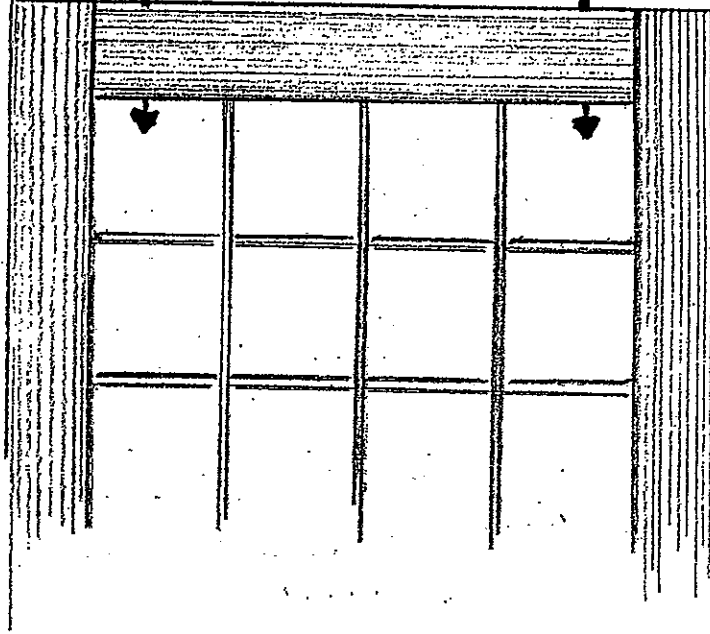

# FACE MOUNT DOOR TROLLEYS

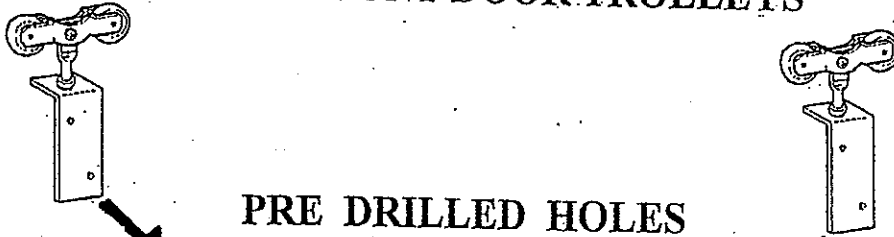

PRE DRILLED HOLES

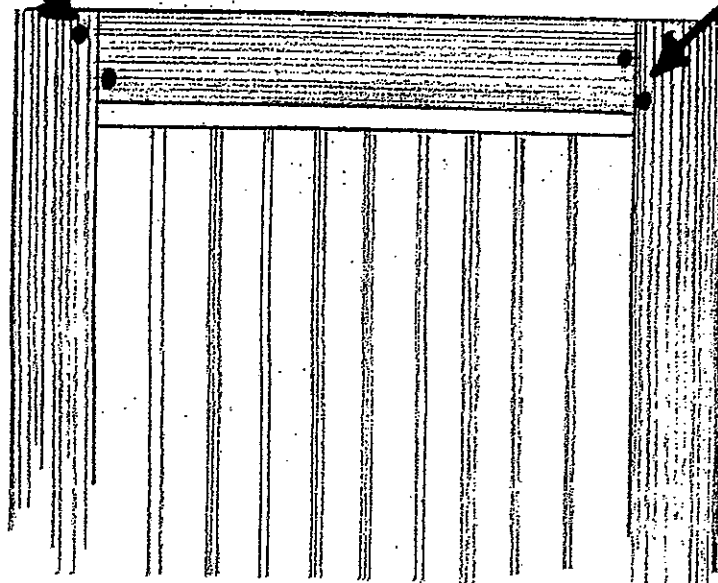

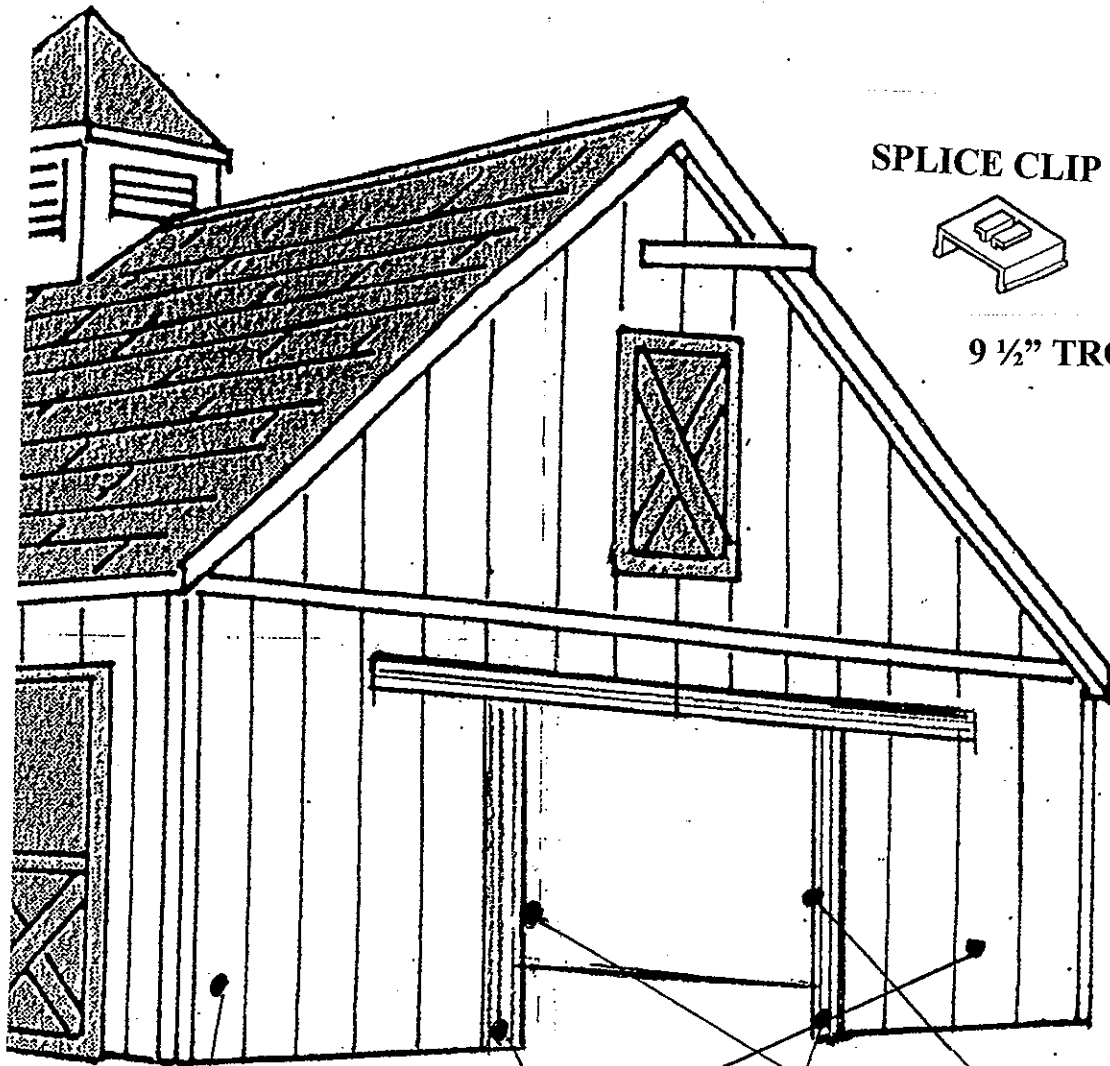

SPLICE CLIP

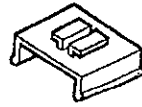

9 1/2" TROLLY HANGER

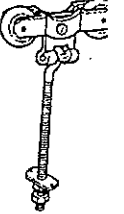

ADJUSTABLE DOOR STOP

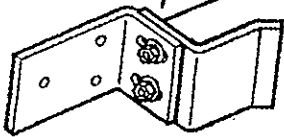

HEAVY DUTY STAY ROLLER

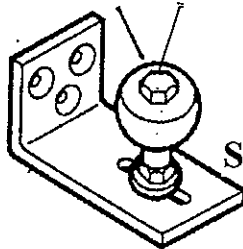

STRIKER PLATE

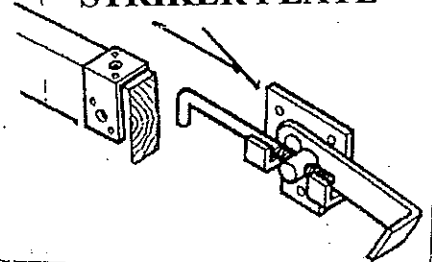

STAY-TIGHT ADJUSTABLE LATCH

# CUSTOM BARN DOOR SPECIFICATIONS

